

服务热线/Service Hotline

400-826-1123



宁波宏大电梯有限公司
NINGBO HOSTING ELEVATOR CO., LTD.

浙江省宁波市鄞州区东吴镇
Dongwu Town Yinzhou District, Zhejiang Province, China

销售热线: 0574-88378555

传真: 0574-88489106-201

邮箱: hd@nxbd.com

网址: www.hosting-china.com

Sales hotline: 0574-88378555

Fax: 0086 574-88336161

Email: inquiry@nxbd.com

Website: www.hosting-china.com

本书为一般信息类出版物,我们保留随时更改产品设计和说明的权利,所有图片和颜色可能与实物有所不同,请以实物为准。宁波宏大电梯版权所有
This manual is an ordinary information publication. We reserve the right to change our product design and instructions at any time. All the pictures and colors may be differ slightly from the reality.
The reality shall prevail in this case. Copyright: NINGBO HOSTING ELEVATOR CO., LTD. all rights reserved

2019年7月版



宏大电梯门户网站

家用电梯 HOME ELEVATOR

定制您的专属生活
Customize Your Exclusive Life

HOSTING
宏大电梯

出色细节 源自精湛工艺
人文关怀 始于匠心设计
宁波宏大SVE系列、VLA系列、BVE系列、HGD家用电梯
为空间赋予价值
让建筑灵活生动
每一次起落
都是独属于您的美好生活

Outstanding detail comes from exquisite craft
Humanistic care begins with ingenious design
Ningbo Hosting SVE series, VLA series, BVE series,
HGD home elevator
Give value to the space
Make the building flexible and vivid
Every experience
It's all your wonderful life



**CUSTOMIZE
YOUR
EXCLUSIVE LIFE**
定制您的专属生活



COMFORTABLE, ENJOY A GREAT LIFE

舒适, 享受非凡人生

优越主机

全新稀土材质永磁同步无齿轮曳引机, 运行平稳, 提升舒适感。

Superior traction machine

New rare earth permanent magnet synchronous gearless traction machine, run smoothly and improve the riding comfort.

平稳降噪

领先控制系统, 精确控制运行速度, 启停平稳舒适, 减少噪音烦扰。

Stable noise reduction

The leading control system, accurate control of the speed of operation, stop smooth and comfortable, reduce noise disturbing.

节能低耗

专为家用电梯设计的主机, 运行宁静, 可使用220V或380V电压, 广泛适用于不同家庭, 耗电量相当于一台冰箱。

Energy saving and low consumption

The machine is designed for home elevator, it runs quietly, can use 220V or 380V voltage, widely applicable to different families, power consumption is equivalent to a refrigerator.

绿色照明

LED照明系统, 光线柔和舒适, 相比传统白炽灯而言, 节能效果出众, 使用寿命也更长久。

Green lighting

LED lighting system, soft and comfortable light, compared with traditional incandescent lamps, energy saving effect is superior, the service life is longer.

SAVE ENERGY, OPEN GREEN FUTURE

节能, 开启绿色未来



INTELLIGENT, SHOW INTIMATE EXPERIENCE

智能, 尽显贴心体验

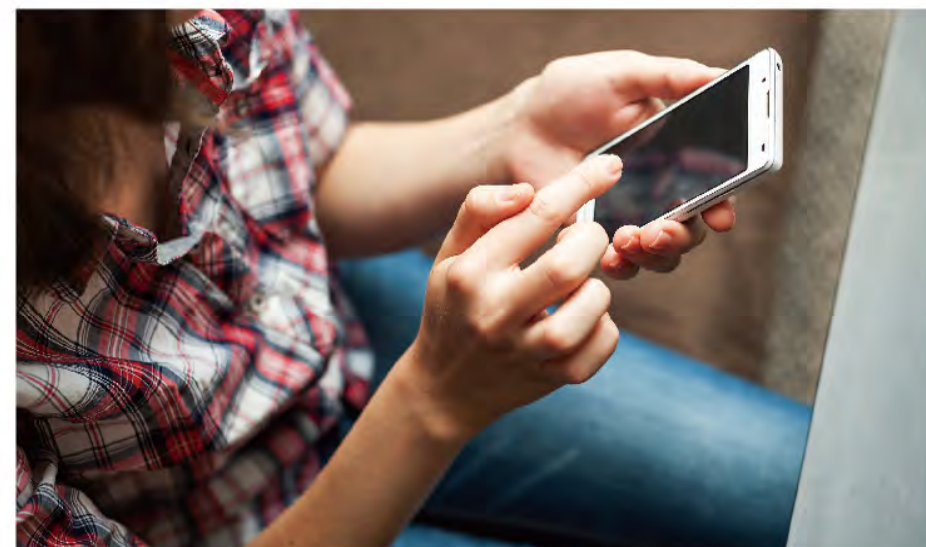

智能对讲

预留外部接口, 能够预存电话, 查询信息, 显示电梯报警记录和呼叫转移等功能, 还能进行实时通话对讲, 保证用户安全可靠地与外界通讯。

Intelligent intercom

The reserved external interface can pre-store the telephone, inquire information, display the elevator alarm record and call transfer and other functions, and can also carry out real-time intercom, ensure that the users can communicate with the outside world safely and reliably.

智能识别

IC卡识别、指纹识别等多种识别系统, 操作简便, 便利高效。

Intelligent identification

IC card identification, fingerprint identification and other identification systems, easy to operate, convenient and efficient.

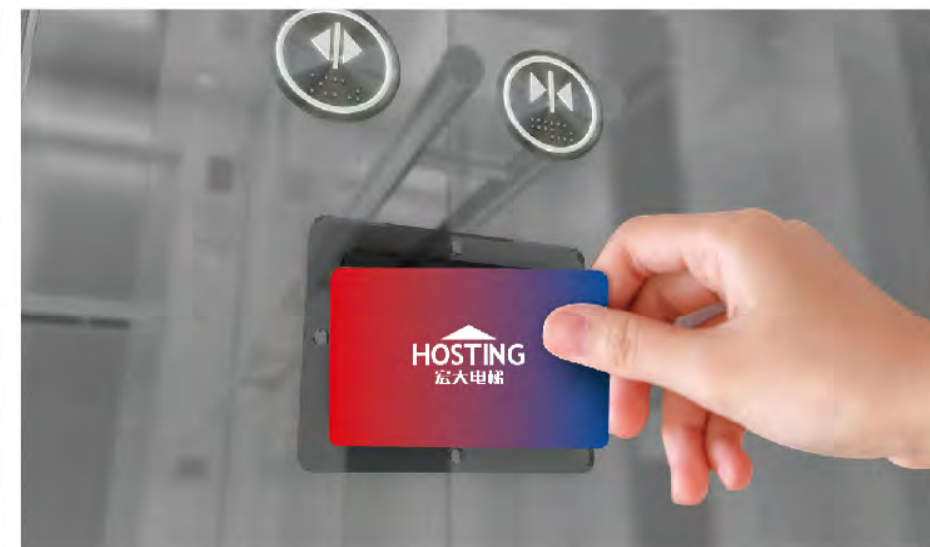

SECURITY, GUARD THE FAMILY ALL THE TIME

安全, 全程守卫家人

应急救援

专门定制的EPS系统将在停电或故障困人时自动启动, 提供应急电源, 同时提醒被困人员电梯当前的信息和操作, 保证电梯运行至平层位置, 开门疏散乘客, 永不关人。

Emergency rescue

Specially customized EPS system will automatically start up in case of power failure or people trapped in lift, provide emergency power supply, remind the trapped people of the current information and operation of the elevator, ensure the elevator runs to the levelling position, open the door to evacuate passengers, and never trap people.



重重防护

红外光幕门, 防止意外夹人; 多重安全保护装置, 环环紧扣, 保护家人的安全。

Heavily

Infrared light curtain door, Multiple protection; door prevents people from being caught accidentally. Multiple safety devices are efficient to protect the family's safety.

SVE SERIES STRONG DRIVE ELEVATOR

SVE系列强驱式电梯

小井道大空间
自带专用框架
轻量化集成
模块化预制

Small shaft large space
Built-in special frame
Lightweight integration
Modular prefabrication



SVE



- ◆ 无对重结构,轿厢自重降低,主机布置灵活,井道利用率提升30%以上。
- ◆ 自带专用框架,结构灵活紧凑,低底坑设计,最小占地面积1300mm×1100mm。
- ◆ 可安装于楼梯中间,四面玻璃设计,打造更好的观光效果。
- ◆ 工厂内模块化预制,现场积木式安装。
- ◆ 轻量化集成,使用强度足够且轻量化的材料进行安装,提升承载舒适性。
- ◆ 可选多种框架和轿厢,完美融合家居风格。外呼、操纵箱标配触摸式液晶屏,保证美观的同时也更易操作。

- ◆ No counterweight structure, car weight is reduced, flexible machine layout, shaft utilization rate increased by more than 30%.
- ◆ Its own special frame, flexible and compact structure, low bottom pit design, minimum floor area of 1300mmx1100mm.
- ◆ Can be installed in the middle of the stairs, four sides are glass design, to create a better sightseeing effect.
- ◆ Factory modular prefabrication, field building block type installation.
- ◆ Lightweight integration, use enough strength and lightweight materials for installation, to enhance the riding comfort.
- ◆ Can choose a variety of frame and car, integrate with the home style perfectly. The touch type LCD screen is standard configuration for HOP and COP, it ensures the beauty and facilitates the operation at the same time.

SVE系列专用控制柜

智能控制,响应迅速,信号传输迅速稳定。

SVE series special control cabinet

Intelligent control, quick response, fast and stable signal transmission.

自适应转速控制技术

自动调整运行曲线,确保电梯高效稳定的运载。

Adaptive speed control technology

Automatically adjust the operation curve to ensure the efficient and stable operation of the elevator.

INTELLIGENT DRIVE

智能驱动



APPLICABLE OCCASIONS

适用场合

人性化的设计理念, 让宁波宏大家用电梯能适用于多种楼房结构。

The humanization design concept makes Ningbo Hosting home elevator suitable for variety of building structures.



以下四种楼房结构均可安装

The following four kinds of building structure can be installed

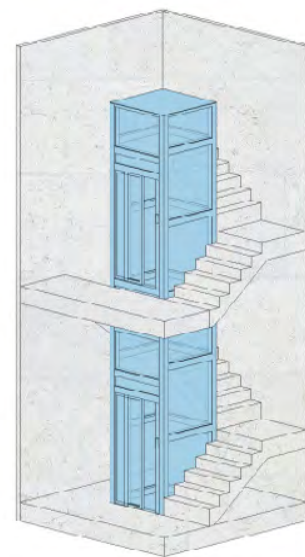

环绕楼梯中间
Surround in the middle of stairs

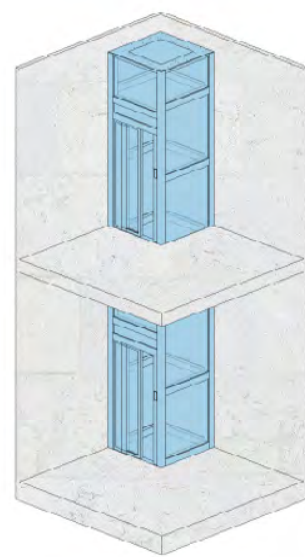

混凝土井道
Concrete shaft

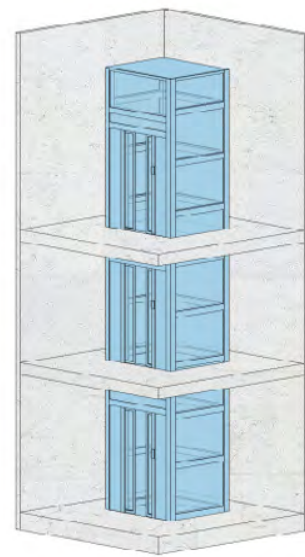

室内楼板开孔
The indoor floor opening

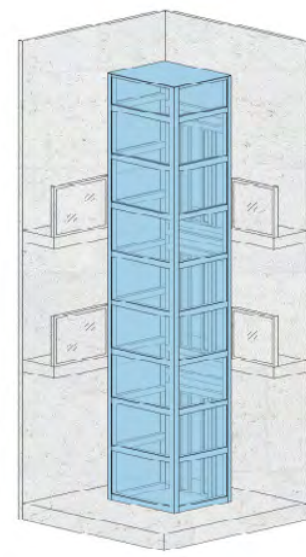

中控大厅
Central control hall

SHAFT FRAME

井道框架

您可以根据个人喜好以及楼层的装修风格确定框架的材质和颜色, 让电梯充满个性, 成为生活中的点睛之作。

You can determine the material and color of the frame according to your personal preference and the decoration style of the floor, making the elevator be full of personality and becoming the finishing point in life.

井道框架产品配置(型材)

Shaft frame product configuration (profile)



象牙白



香槟金



HD-1802



XD34烟灰白

井道侧板 (钢化玻璃)

Side plate of shaft (Tempered glass)



烟灰色
Smoke grey



全透明
Transparent



SVE-1805

• 吊顶 Ceiling

木质吊顶, LED或灯带照明
Wooden ceiling, LED or light illumination

• 轿壁 Car wall

铝合金一体式轿壁,
模块化安装
Aluminum alloy integrity car wall, modular installation

• 平板操纵箱 Tablet operation panel

内嵌全触摸平板操纵箱,
个性化选择
Embedded full-touch tablet operation panel, personalized choice

内嵌全触摸平板操纵箱,
个性化选择
Embedded full-touch tablet operation panel, personalized choice

• 地板 Floor

Floor

PVC
PVC

SVE SERIES STANDARD CONFIGURATION

SVE 系列标准配置



舒适的移动空间
Comfortable moving space

SVE系列专用操纵箱(可选)

SVE series special operation panel (optional)

触摸屏操纵箱

Touch screen operation panel



外挂式: COP-10TA
内嵌式: COP-10TB

楼层、开关门、照明风扇
控制家庭照片、客户LOGO显示
楼层数量、横竖显示界面菜单可设

External installation type: COP-10TA
Embedded type: COP-10TB

Floor, door open and close, lighting and fan
Family photos, customer logo display
The number of floor, horizontal and vertical display can be set in the interface menu.

SVE系列专用外呼(可选)

SVE series special calling board (optional)

触摸型外召盒

Touch screen calling board



HOP-04TA

外挂安装, 4.2寸TFT显示屏
触摸式呼梯操纵, 触摸按钮发亮显示效果
实时显示电梯状态、运行方向、层站位置
蓝底白字、黑底白字两款界面可选

External installation, 4.2 inch TFT display
Touch-screen call control, touch button display effect.

Real time display of elevator status, operation direction and floor position
white character on blue background and white character on black background are optional.

可选地板

Optional floor

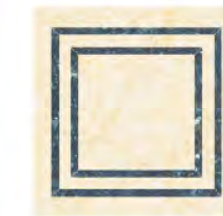

NHD-1702 (PVC)



NHD-1401 (PVC)

轿壁可选材质

Optional material for car wall



钢化玻璃
Tempered glass



烟灰色
Smoke grey

全透明
Transparent



VLA

底坑深度最小500mm
 顶层高度最低2900mm
 无需专用机房
 载重规格多样

Minimum pit depth is 500mm
 Minimum top floor height 2900mm
 No special machine room is required
 Various load specifications

- ◆ 大幅降低对底坑深度和顶层高度的要求,为设计和安装增添更多自由。
- ◆ 无需专用机房,节省大量建筑空间和建设费用。
- ◆ 多种载重规格,应对各种需求,最大可达400kg。
- ◆ 领先的家用电梯专用主机,传动效率高,力矩大,运载更为稳定。

- ◆ Significantly reduce the requirements for pit depth and top floor height, add more freedom for design and installation.
- ◆ No need special machine room, save a lot of building space and construction costs.
- ◆ A variety of load specifications, meet a variety of needs, up to 400kg.
- ◆ The leading machine of home elevator has high transmission efficiency and large torque, and the operation is more stable.

VLA SERIES TRACTION ELEVATOR

VLA系列曳引式电梯

FASHIONABLE AND BEAUTIFUL 时尚美观

VLA-1501

可选配置
Optional configuration

- **吊顶**
Ceiling
镜面不锈钢, 筒灯
Mirror stainless steel, down light
- **轿壁**
Car wall
发纹不锈钢、安全玻璃
Hairline stainless steel, safety glass
- **扶手**
Handrail
不锈钢扶手
Stainless steel handrail
- **地板**
Floor
PVC
PVC

舒适的移动空间
Comfortable moving space



VLA-1503

可选配置
Optional configuration

- **吊顶**
Ceiling
镜面蚀刻古铜, 亚克力灯罩
Mirror etching antique brass, acrylic lampshade
- **轿壁**
Car wall
发纹、镜面、蚀刻、古铜
Hairline, mirror, etching, antique brass
- **地板**
Floor
PVC
PVC

致力于打造高品位的轿内环境
To create high quality environment in the car



VLA-1504

可选配置
Optional configuration

- **吊顶**
Ceiling
乳白色亚克力透光板, 木饰面
Milk white acrylic transparent plate,
wood decoration
- **轿壁**
Car wall
玻璃镜、木饰面
Glass mirror and
wood decoration
- **地板**
Floor
PVC
PVC

舒适的移动空间
Comfortable moving space

OPTIONAL ELEVATOR CAR

选配轿厢



VLA-1901

可选配置
Optional configuration

- **吊顶**
Ceiling
钛金镜面不锈钢、
影像透光板、筒灯
Titanium mirror stainless steel over light panel,
down lamp
- **轿壁**
Car wall
钛金镜面不锈钢、安全玻璃
Titanium mirror stainless steel, safety glass
- **扶手**
Handrail
实木和钛金组合
Combination of solid wood and titanium
- **地板**
Floor
PVC
PVC

致力于打造高品位的轿内环境
To create high quality environment in the car



- ◆ 无偏载设计, 运行时导靴与导轨之间摩擦力极低, 极大提高了导靴的使用寿命与轿厢运行平稳度。
 - ◆ 结合龙门架的结构优势, 井道布置更为紧凑, 对顶层高度和底坑深度的要求低, 只需很小的空间就能进行安装, 适应性更强。
 - ◆ 无提升高度限制; 配备专用主机, 耗电量低, 更为节能。
 - ◆ 无论您的住宅是已建成还是仍在建造, 都能便捷的进行电梯安装。
- ◆ Unbiased load design, very low friction between the guide shoe and the guide rail during operation, greatly improve the service life of guide shoe and car running stability.
 - ◆ Combined with the structural advantages of the car frame, the shaft layout is more compact, the requirements for top floor height and pit depth are low. It can be installed in a very small space, and it is more adaptable.
 - ◆ No lifting height limit; Equipped with a special machine, low power consumption, more energy saving.
 - ◆ Whether your home is built or still under construction, you can easily install elevators.

BVE SERIES BACKPACK RACK ELEVATOR

BVE系列背包架式电梯



BVE

无偏载设计
无提升高度限制
紧凑布置方案

Unbiased design
No lifting height limit
Compact layout

PLASTIC-WRAPPED WIRE ROPE

裹塑钢丝绳

- ◆ 维护简便: 后期无需维护和润滑。
 - ◆ 舒适度高: 钢丝绳外部包裹聚合物涂层, 可以消除或吸收震动, 防止钢节轴向偏移, 运行舒适平稳。
 - ◆ 持久耐用: 由于曳引机的轮槽与电梯钢丝绳不易磨损, 钢丝绳的更换频率及相关成本将大幅降低。
- ◆ Easy maintenance: no maintenance and lubrication required.
 - ◆ High comfort: the steel wire rope is coated with polymer coating, which can eliminate or absorb vibration, prevent the axial deviation of the steel node, running comfortably and smoothly.
 - ◆ Durable: due to the traction sheave groove and elevator wire rope is not easy to wear, wire rope replacement frequency and related costs will be greatly reduced.

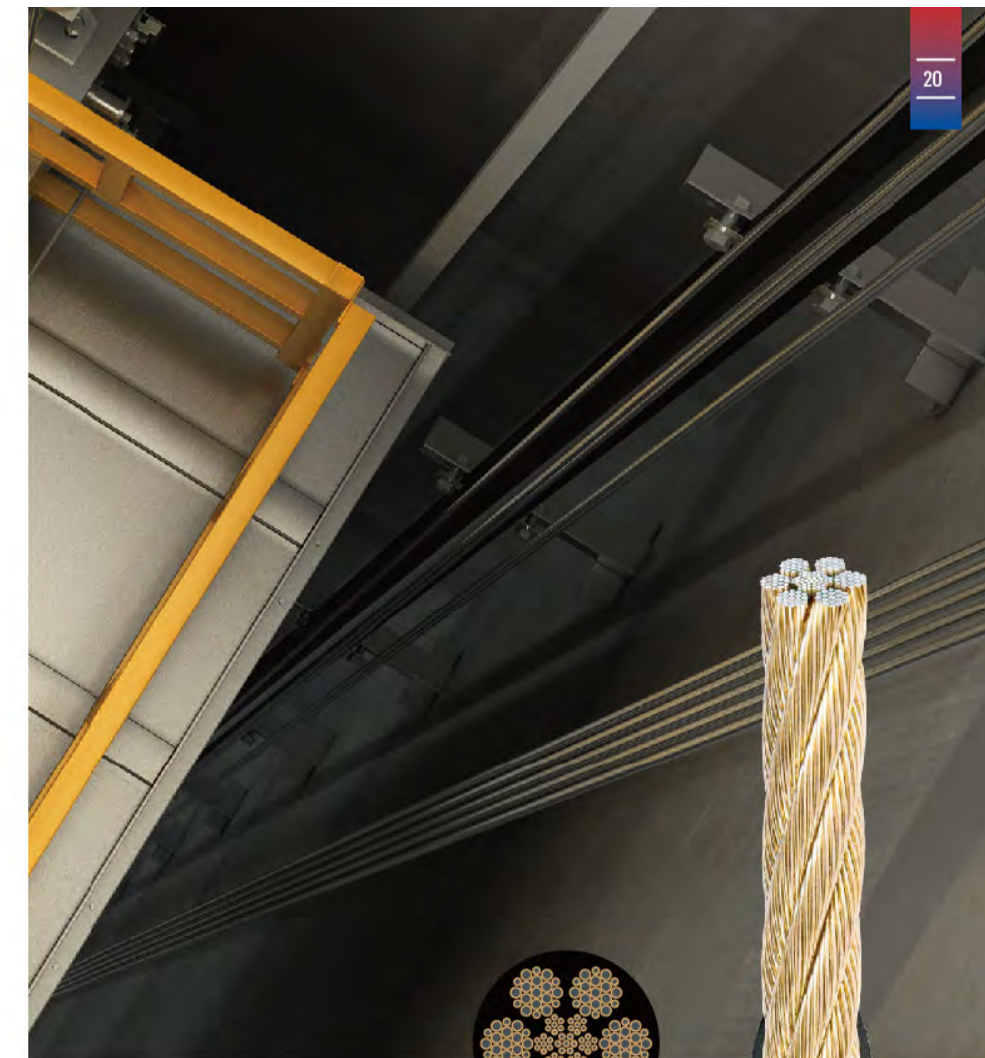

BVE系列背包架式电梯采用裹塑钢丝绳, 具有维护简便、舒适度高、持久耐用等优势。

BVE series knapsack rack elevator adopt plastic wrapped wire rope, which has the advantages of easy maintenance, high comfort and durability.

BVE-1901

可选配置
Optional configuration

- **吊顶**
Ceiling
短丝发纹香槟金板,短丝发纹
香槟金边框,筒灯及回光照明
Short hairline champagne gold panel,
short hairline champagne gold frame,
down lamp and backlight lighting
- **轿壁**
Car wall
镜面、蚀刻、香槟金、木饰面
Mirror, etching, champagne gold, wood
- **扶手**
Handrail
香槟金扶手
Champagne gold handrail
- **地板**
Floor
PVC
PVC

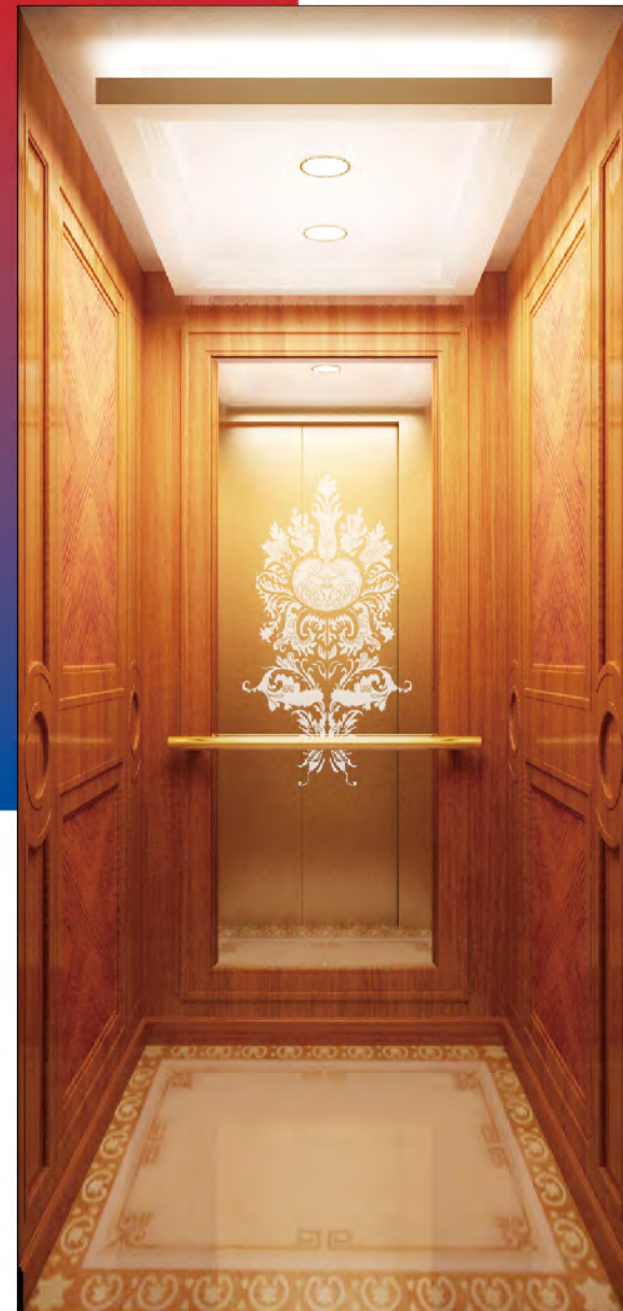

OPTIONAL ELEVATOR CAR

选配轿厢

BVE-1902

可选配置
Optional configuration

- **吊顶**
Ceiling
短丝发纹板,短丝发纹边框,
筒灯及回光照明
Short hairline panel, short hairline frame,
down lamp and backlight lighting
- **轿壁**
Car wall
镜面、蚀刻、木饰面
Mirror, etching, wood
- **地板**
Floor
PVC
PVC



致力于打造高品位的轿内环境
To create high quality environment in the car

HD-1911

可选配置
Optional configuration

- 吊顶
Ceiling
玫瑰金镜面、拱形亚克力、LED照明
Rose gold mirror, arched acrylic, LED lighting
- 轿壁
Car wall
镜面、蚀刻、玫瑰金、短丝发纹
Mirror, etching, rose gold, short hairline
- 扶手
Handrail
不锈钢扁扶手
Stainless steel flat handrail
- 地板
Floor
PVC
PVC

CAR DECORATION SERIES

轿厢装潢系列



HD-1912

可选配置
Optional configuration

- 吊顶
Ceiling
镜面边框、筒灯、喷绘板
Mirror frame, down lamp, inkjet plate
- 轿壁
Car wall
镜面、蚀刻、凹部金色、短丝发纹
Mirror, etching, golden concave, short hairline
- 扶手
Handrail
实木和钛金组合
Combination of solid wood and titanium
- 地板
Floor
PVC
PVC

致力于打造高品位的轿内环境
To create high quality environment in the car



HD-1913

可选配置
Optional configuration

- **吊顶**
Ceiling
镜面边框、亚克力喷绘板
Mirror frame, acrylic inkjet plate
- **轿壁**
Car wall
镜面、蚀刻、手工发纹、凹部金色、短丝发纹
Mirror, etching, handmade hairline, golden concave, short hairline
- **扶手**
Handrail
不锈钢圆扶手
Stainless steel round handrail
- **地板**
Floor
PVC
PVC

舒适的移动空间
Comfortable moving space

OPTIONAL ELEVATOR CAR

选配轿厢



HD-1914

可选配置
Optional configuration

- **吊顶**
Ceiling
镜面香槟金边框、筒灯、镜面蚀刻
香槟金、亚克力灯罩
Champagne gold mirror frame, down lamp,
mirror etching champagne gold, acrylic lampshade
- **轿壁**
Car wall
镜面、蚀刻、香槟金、短丝发纹
Mirror, etching, champagne gold, short hairline
- **扶手**
handrail
实木和钛金组合
Combination of solid wood and titanium
- **地板**
Floor
PVC
PVC

致力于打造高品位的轿内环境
To create high quality environment in the car

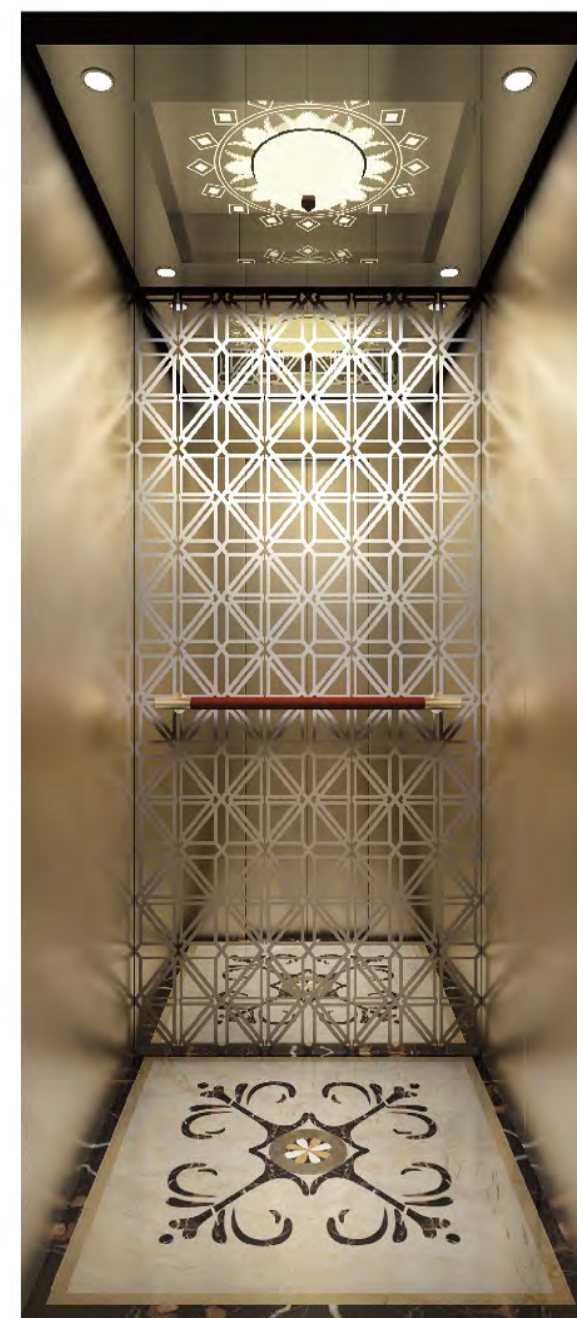

FASHIONABLE AND BEAUTIFUL

时尚美观

HD-1915

可选配置
Optional configuration

• 吊顶 Ceiling

短丝发纹香槟金边框、
LED筒灯及回光照明
Short hairline champagne gold frame,
LED down lamp and backlight lighting

• 地板 Floor

PVC
PVC

舒适的移动空间
Comfortable moving space

• 轿壁 Car wall

镜面、蚀刻、香槟金、
短丝发纹
Mirror, etching, champagne gold,
short hairline



HD-1916

可选配置
Optional configuration

• 吊顶 Ceiling

短丝发纹钛金冲孔、亚克力
及LED筒灯
Short hairline titanium punching,
acrylic and LED down lamp

• 轿壁 Car wall

镜面、蚀刻、钛金
Mirror, etching, titanium

• 地板 Floor

PVC
PVC

致力于打造高品位的轿内环境
To create high quality environment in the car



操纵箱/外呼

Operation panel / calling board

可选显示

Optional display



PB1017
彩色液晶, 7寸
(可变图片显示模式)
Color LCD, 7 inches
(variable image
display mode)



PB1013
3.5寸
蓝色液晶
Blue LCD
3.5 inches



PB1018
3.5寸
蓝色液晶
Blue LCD
3.5 inches

超薄型操纵箱

Ultra-thin operation panel

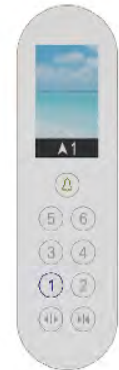

COP-B1
白色钢化玻璃
White tempered glass



COP-B2
黑色钢化玻璃
Black tempered glass



COP-A1
发纹不锈钢
White stainless steel



COP-A2
钛金不锈钢
Titanium stainless steel



COP-A3
黑钛不锈钢
Black titanium stainless steel

标准配置

Standard configuration



COP-08



HOP-08

圆形外召盒

Round calling board

圆形外召盒——不锈钢系列

Round calling board - stainless steel series



HOP-A01
蓝色彩圈
Blue circle



HOP-A11
蓝色彩圈
Blue circle



HOP-A21
蓝色彩圈
Blue circle



HOP-A31
蓝色彩圈
Blue circle



HOP-A12
黄色彩圈
Yellow circle



HOP-A22
黄色彩圈
Yellow circle



HOP-A32
黄色彩圈
Yellow circle

圆形外召盒——锌合金系列

Round calling board - Zinc alloy series



HOP-B11
黄色彩圈
Yellow circle



HOP-B12
蓝色彩圈
Blue circle

可选厅门

Optional hall door



NTD-1901



NTD-1902



NTD-1903



NTD-1904



NTD-1905



NTD-1906



NTD-1907



NTD-1908



NTD-1909



NTD-1910

可选地板 (PVC/大理石)

Optional floor (PVC/marble)



NHD-1702 (PVC)



NHD-1412



NHD-1401 (PVC)



NHD-1418

可选面板材质

Optional panel materials



发纹不锈钢
Hairline
stainless steel



镜面不锈钢
Mirror
stainless steel



钛金不锈钢
Titanium
stainless steel



玫瑰金
Rose gold



钛黑
Titanium black

ELEVATOR CONTROL SYSTEM CONFIGURATION

电梯控制系统配置

运行功能

Operation function



集选控制	Selective collective control
本层厅外开门	Landing door opens at the current floor
层高自动测定	The height automatic measurement
厅门、轿门时间分别控制	Time of landing door and car door are controlled respectively
轿内误指令消除	Car error instructions elimination
直接停靠	Direct stop
自动返基站	Automatic return to base station
自动泊梯	Automatic parking
故障低速自救功能	Fault low-speed save function
开门异常手动选层自救功能	Manual floor selection and self-rescue in case of abnormal door opening

安全功能

Safety function



超载保护	Overload protection
超载报警	Overload alarm
超速保护	Overspeed protection
光幕保护	Light curtain protection
运行时间保护	Running time protection
关门受阻保护	Door closing protection
位置异常自动校正	Abnormal position automatic correction
故障自动检测和存储	Error automatic detection and storage
抱闸监控功能	Brake monitoring function
接触器反馈检测功能	Contactors feedback detection
终端楼层保护	Terminal floor protection
检修操作	Inspection operation



人机界面

The man-machine interface

运行次数显示	Indication of the number of run
运行时间显示	Indication of run time
轿内及厅外数码显示	Digital indication for car and hall call
轿内及厅外方向指示	Direction indication for car and hall call
检修状态提醒显示	Inspection status indication



应急功能

Emergency function

报警装置	Alarm device
应急照明	Emergency lighting
轿厢警铃	The car alarm
机房紧急电动运行	Emergency electric operation in machine room



节能功能

Energy saving function

轿内照明自动控制	Automatic lighting control in the car
轿内风扇自动控制	Fan automatic control (fac) in the car
停止服务锁	Service stop lock



家用电梯专用功能

Special function of the home elevator

语音提示	Voice prompt
智能语音通话	Intelligent voice calls
智能救援系统	Intelligent rescue system
检修安全装置	Inspection safety device



选配功能

Optional features

身份IC卡识别控制*	Identity identification IC card control*
------------	--

SVE SERIES CONSTRUCTION PARAMETERS

SVE系列土建参数

强驱家用电梯(SVE)标准土建技术参数															
额定载重 (Kg)	额定速度 (m/s)	型号	轿厢规格			门规格		井道内净尺寸				曳引机位置	轿厢观光情况	井道结构	
			宽AA (mm)	深BB (mm)	高HK (mm)	开门方式	宽JJ (mm)	高HH (mm)	宽A (mm)	深B (mm)	底坑KH (mm)				顶层OH (mm)
320	0.4	SVE320-A	950	900	2200	双折	700	2000	1300	1250	300	3300	上置	观光	铝框架
		SVE320-B	950	900	2200	双折	700	2000	1300	1250	300	3000	下置	观光	铝框架
		SVE320-C	950	900	2200	双折	700	2000	1300	1250	300	3300	上置	观光	钢框架
		SVE320-D	950	900	2200	双折	700	2000	1300	1250	300	3000	下置	观光	钢框架
		SVE320-E	950	900	2200	双折	700	2000	1350	1300	300	3300	上置	非观光	砖混/钢结构
		SVE320-F	950	900	2200	双折	700	2000	1350	1300	300	3000	下置	非观光	砖混/钢结构
400	0.4	SVE400-A	1200	1100	2200	中分	700	2000	1550	1350	300	3300	上置	观光	铝框架
		SVE400-B	1200	1100	2200	中分	700	2000	1550	1350	300	3000	下置	观光	铝框架
		SVE400-C	1200	1100	2200	中分	700	2000	1550	1350	300	3300	上置	观光	钢框架
		SVE400-D	1200	1100	2200	中分	700	2000	1550	1350	300	3000	下置	观光	钢框架
		SVE400-E	1150	1100	2200	中分	700	2000	1550	1450	300	3300	上置	非观光	砖混/钢结构
		SVE400-F	1150	1100	2200	中分	700	2000	1550	1450	300	3000	下置	非观光	砖混/钢结构

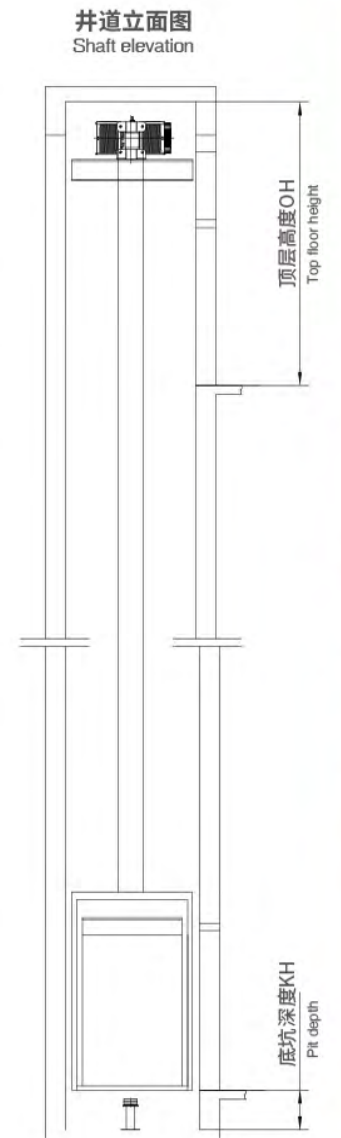
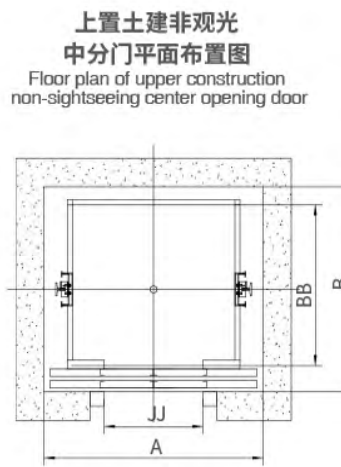
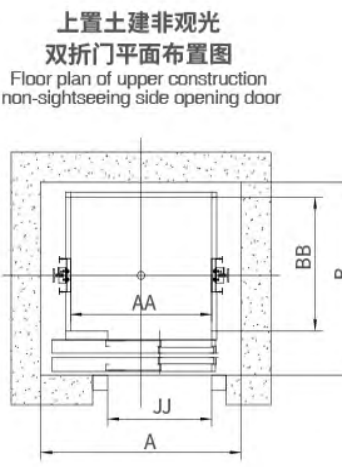
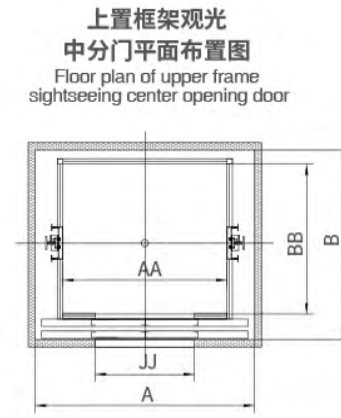
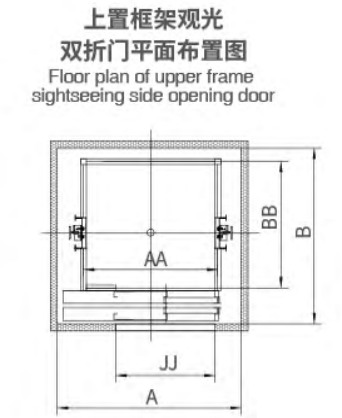
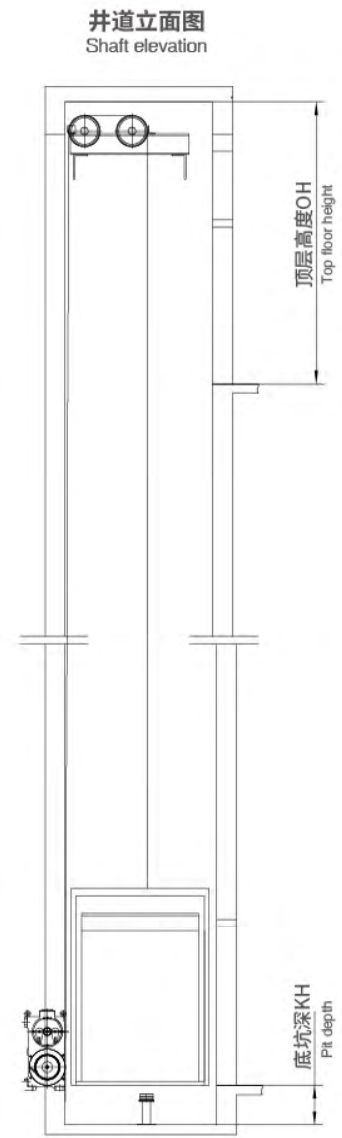
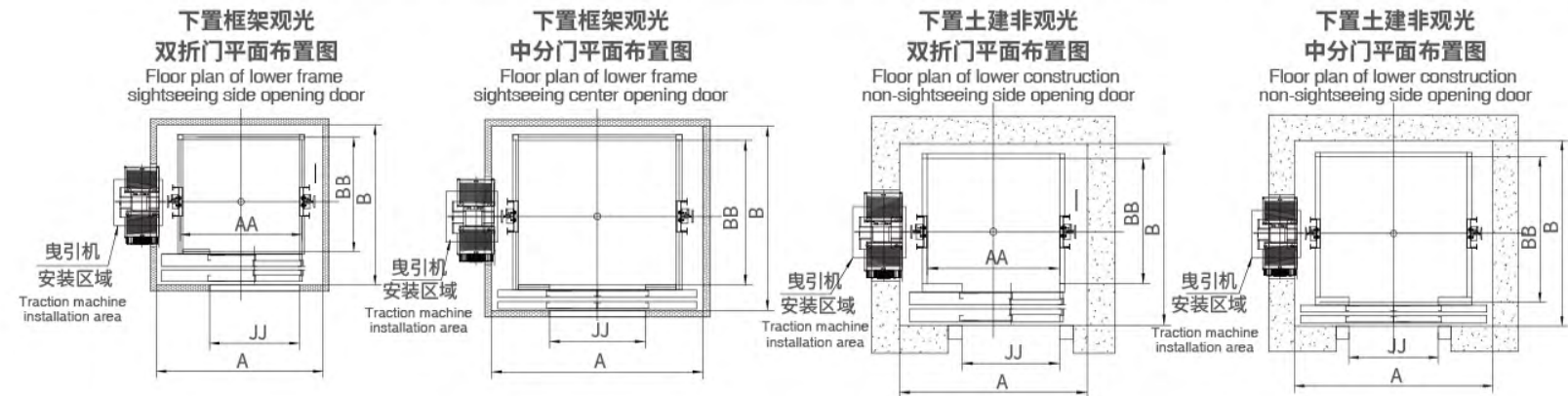

VLA SERIES CONSTRUCTION PARAMETERS

VLA系列土建参数

VLA系列电梯主要技术参数										
额定载重/额定乘客 (KG/人)	额定速度 (m/s)	轿厢规格		门规格			井道尺寸			
		净宽AA (mm)	净深BB (mm)	净宽JJ (mm)	净高HH (mm)	开门方式	框架外宽度A (mm)	框架外深度B (mm)	底坑深PH (mm)	顶层净高OH (mm)
320/4	0.4	900	1200	800	2000	中分双折	1600	1600	500	2900
		900	1200	800	2000	双折	1600	1600	500	2900
		1000	1200	800	2000	中分	1750	1600	500	2900
400/5	0.4	1000	1300	800	2000	中分双折	1700	1700	500	2900
		1000	1300	800	2000	双折	1700	1700	500	2900
		1000	1300	800	2000	中分	1750	1700	500	2900

井道平面图(旁开)
Shaft layout (side opening)

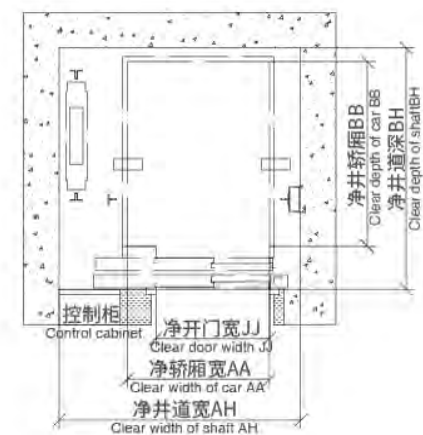

井道平面图(中分)
Shaft layout (center opening)

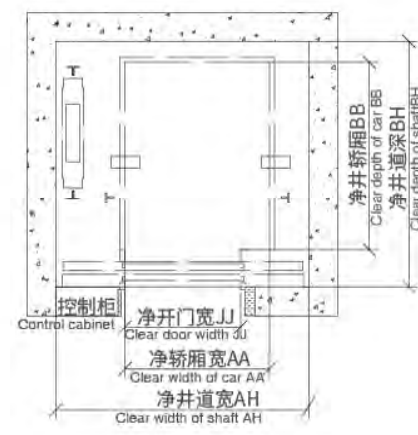

井道平面图(中分双折式)
Shaft layout (center opening & double-folded type)

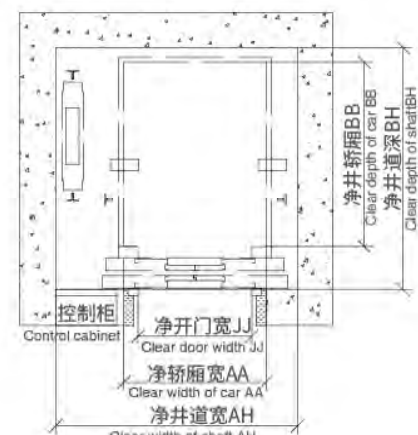

井道立面图
Shaft elevation

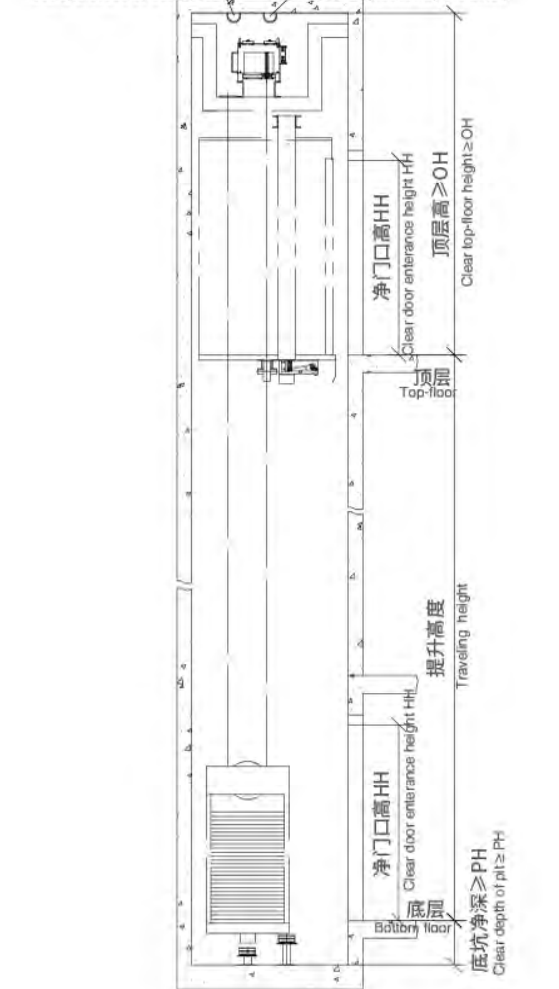

BVE SERIES CONSTRUCTION PARAMETERS

BVE系列土建参数

背包架家用电梯(BVE)土建技术参数														
额定载重 (Kg)	额定速度 (m/s)	型号	轿厢规格			门规格			井道尺寸				轿厢反绳轮位置	配重位置
			宽AA (mm)	深BB (mm)	高HK (mm)	开门方式	宽JJ (mm)	高HH (mm)	宽A (mm)	深B (mm)	底坑KH (mm)	顶层OH (mm)		
320	0.4	BVE-A-320	1100	850	2200	中分双折	750	2000	1300	1420	300	3200	上置	后置
400	0.4	BVE-A-400	1300	950	2200	中分双折	800	2000	1500	1520	300	3200	上置	后置

井道平面图
Shaft layout

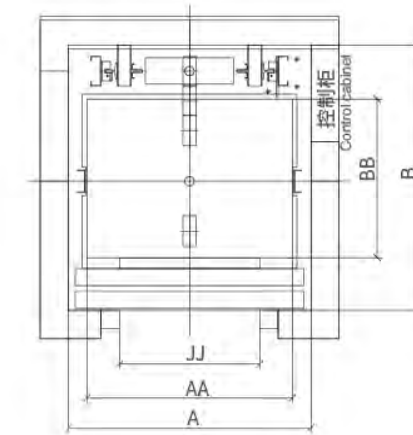

井道立面图
Shaft elevation

